

ITEM NO.	DESCRIPTION	QTY.
1	RNG_25_3.5_22	1
2	WSR_25_XX_22	1
3	CHROMA FILTER	1

REVISIONS		
REV	DESCRIPTION	DATE
A	INITIAL RELEASE	2/3/2021

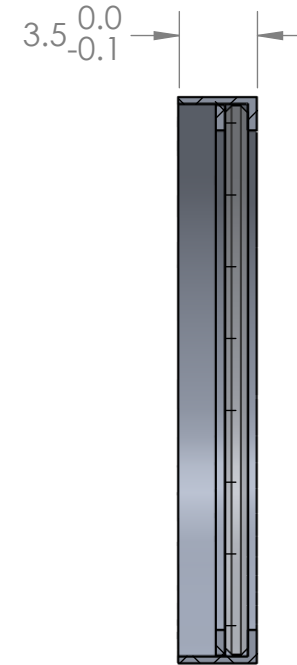
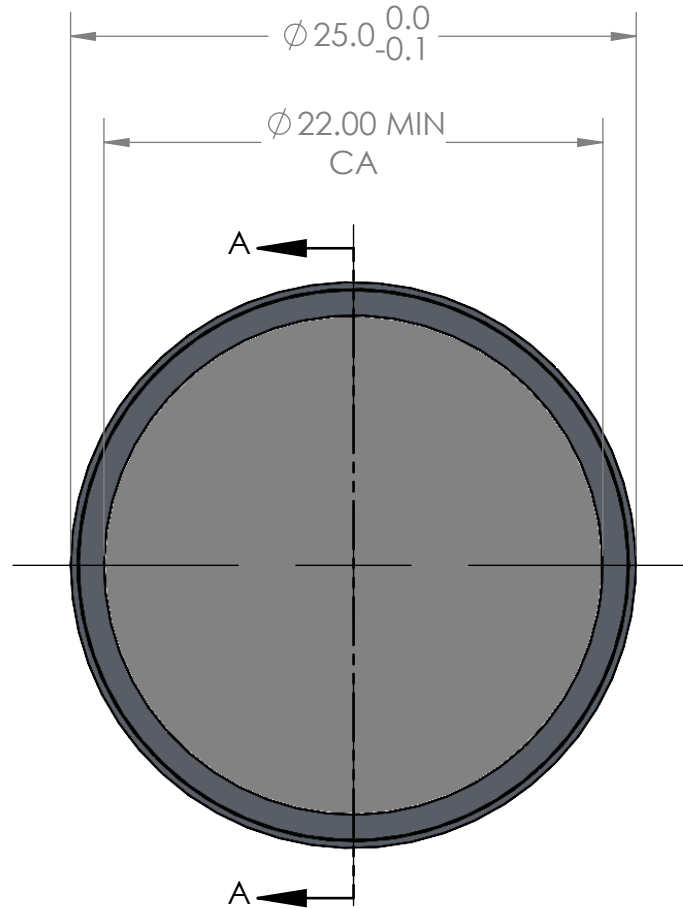
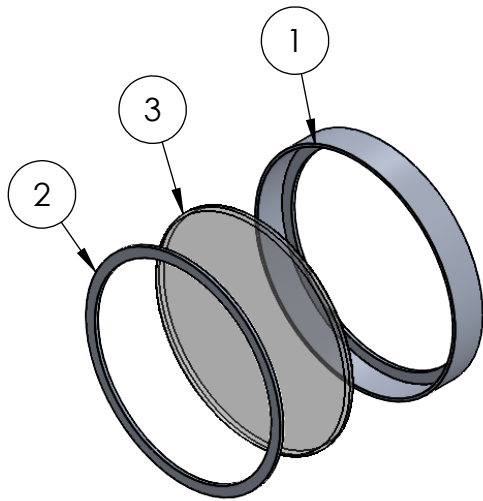

SECTION A-A

TITLE RNGASSM_25_3.5_22_SALES		NAME	DATE	UNLESS OTHERWISE SPECIFIED: DIMENSIONS ARE IN MILLIMETERS TOLERANCES: FRACTIONAL: $\pm 1/64$ ANGULAR: MACH $\pm 0.5^\circ$ BEND $\pm 0.5^\circ$ x. ± 2 .x ± 1 .xx ± 0.05	CHROMA TECHNOLOGY CORP
DRAWN BY		CRP	2/3/2021		
MTHDS APPR.				MATERIAL:	
ENG APPR.					
ID 009663_SALES	SCALE 3:1	PRD ENG APPR.	N/A	FINISH:	
SIZE A	SHEET 1 OF 1	REVISION A	COMMENTS		